

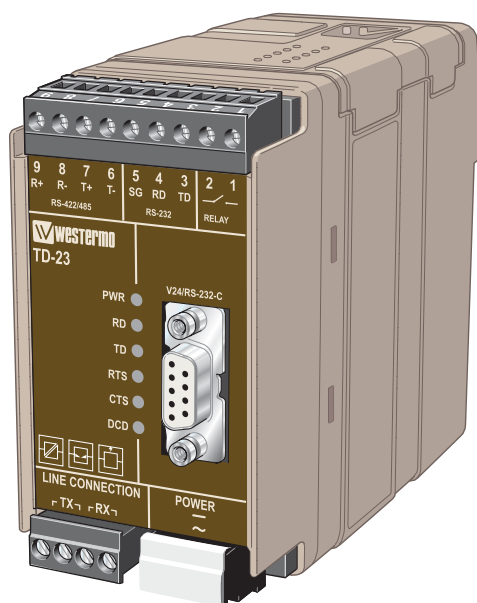

# TD-23

6600-2204



**Leased Line  
V.23 Modem.  
Multidrop applications**

## **Legal information**

The contents of this document are provided “as is”. Except as required by applicable law, no warranties of any kind, either express or implied, including, but not limited to, the implied warranties of merchantability and fitness for a particular purpose, are made in relation to the accuracy and reliability or contents of this document. Westermo reserves the right to revise this document or withdraw it at any time without prior notice.

Under no circumstances shall Westermo be responsible for any loss of data or income or any special, incidental, and consequential or indirect damages howsoever caused.

More information about Westermo can be found at the following Internet address:

**<http://www.westermo.com>**

## Safety



### **Before installation:**

#### **This modem is for restricted access area use only.**

Read this manual completely and gather all information on the unit. Make sure that you understand it fully. Check that your application does not exceed the safe operating specifications for this unit.

This unit should only be installed by qualified personnel.

This unit should be built-in to an apparatus cabinet, or similar, where access is restricted to service personnel only.

The power supply wiring must be sufficiently fused, and if necessary it must be possible to disconnect manually from the power supply. Ensure compliance to national installation regulations.

This unit uses convection cooling. To avoid obstructing the airflow around the unit, follow the spacing recommendations (see Cooling section).



### **Before mounting, using or removing this unit:**

Prevent access to hazardous voltage by disconnecting the unit from power supply.

Warning! Do not open connected unit. Hazardous voltage may occur within this unit when connected to power supply.

## Care recommendations

Follow the care recommendations below to maintain full operation of unit and to fulfil the warranty obligations.

This unit must not be operating with removed covers or lids.

Do not attempt to disassemble the unit. There are no user serviceable parts inside.

Do not drop, knock or shake the unit, rough handling above the specification may cause damage to internal circuit boards.

Do not use harsh chemicals, cleaning solvents or strong detergents to clean the unit.

Do not paint the unit. Paint can clog the unit and prevent proper operation.

Do not expose the unit to any kind of liquids (rain, beverages, etc). The unit is not waterproof. Keep the unit within the specified humidity levels.

Do not use or store the unit in dusty, dirty areas, connectors as well as other mechanical part may be damaged.

If the unit is not working properly, contact the place of purchase, nearest Westermo distributor office or Westermo Tech support.

## Maintenance

No maintenance is required, as long as the unit is used as intended within the specified conditions.

## Agency approvals and standards compliance

Type	Approval / Compliance
EMC	EN 61000-6-2, Immunity industrial environments
	EN 55024, Immunity IT equipment
	EN 61000-6-3, Emission residential environments
	FCC part 15 Class B
	EN 50121-4, Railway signalling and telecommunications apparatus
	IEC 62236-4, Railway signalling and telecommunications apparatus
Safety	EN 60950-1, IT equipment

### FCC Part 15.105 Notice:

This equipment has been tested and found to comply with the limits for a Class B digital device, pursuant to Part 15 of the FCC Rules. These limits are designed to provide reasonable protection against harmful interference in a residential installation. This equipment generates, uses and can radiate radio frequency energy and, if not installed and used in accordance with the instructions, may cause harmful interference to radio communications. However, there is no guarantee that interference will not occur in a particular installation. If this equipment does cause harmful interference to radio or television reception, which can be determined by turning the equipment off and on, the user is encouraged to try to correct the interference by one or more of the following measures:

- ⌘ Reorient or relocate the receiving antenna
- ⌘ Increase the separation between the equipment and receiver
- ⌘ Connect the equipment into an outlet on a circuit different from that to which the receiver is connected
- ⌘ Consult the dealer or an experienced radio/TV technician for help.

# Declaration of Conformity



Westermo Teleindustri AB

T06-0043

## Declaration of conformity

The manufacturer Westermo Teleindustri AB  
SE-640 40 Stora Sundby, Sweden

Herewith declares that the product(s)

Type of product	Model	Art no	Installation manual
DIN-rail	TD-23 LV	3600-2001	6600-2204
DIN-rail	TD-23 HV	3600-2101	6600-2204

is in conformity with the following EC directive(s).

No	Short name
89/336/EEG	Electromagnetic Compatibility (EMC)
73/23/EEG	Low Voltage Directive - LVD

References of standards applied for this EC declaration of conformity.

No	Title	Issue
EN 61000-6-2	Immunity for industrial environments	2 (2001)
EN 55024	Information technology equipment – Immunity	1 (1998)
EN 61000-6-3	Emission standard for residential, commercial and light-industrial environments	1 (2001)
EN 60950-1	Safety of information technology equipment	1 (2001)

The last two digits of the year in which the CE marking was affixed: 06

Herewith declares that product(s) listed above is in conformity with

No	Title	Issue
FCC part 15	Radio frequency devices	2003

Hans Levin  
Technical Manager  
27h Mars 2006

Postadress/Postal address  
S-640 40 Stora Sundby  
Sweden

Tel.  
016-428000  
Int+46 16428000

Telefax  
016-428001  
Int+46 16428001

Postgiro  
52 72 79-4

Bankgiro  
5671-5550

Org.nr/  
Corp. identity number  
556361-2604

Registered office  
Eskilstuna

## Type tests and environmental conditions

<b>Electromagnetic Compatibility</b>			
<b>Phenomena</b>	<b>Test</b>	<b>Description</b>	<b>Test levels</b>
ESD	EN 61000-4-2	Enclosure contact	± 6 kV
		Enclosure air	± 8 kV
RF field AM modulated	IEC 61000-4-3	Enclosure	10 V/m 80% AM (1 kHz), 80 – 1000 MHz 20 V/m 80% AM (1 kHz), 80 – 2000 MHz
RF field 900 MHz	ENV 50204	Enclosure	20 V/m pulse modulated 200 Hz, 900 ± 5 MHz
Fast transient	EN 61000-4-4	Signal ports	± 2 kV
		Power ports	± 2 kV
Surge	EN 61000-4-5	Signal ports unbalanced	± 2 kV line to earth, ± 2 kV line to line
		Signal ports balanced	± 2 kV line to earth, ± 1 kV line to line
		Power ports	± 2 kV line to earth, ± 2 kV line to line
RF conducted	EN 61000-4-6	Signal ports	10 V 80% AM (1 kHz), 0.15 – 80 MHz
		Power ports	10 V 80% AM (1 kHz), 0.15 – 80 MHz
Power frequency magnetic field	EN 61000-4-8	Enclosure	100 A/m, 50 Hz, 16.7 Hz & 0 Hz
Pulse magnetic field	EN 61000-4-9	Enclosure	300 A/m, 6.4 / 16 µs pulse
Voltage dips and interruption	EN 61000-4-11	AC power ports	10 & 5 000 ms, interruption 10 & 500 ms, 30% reduction 100 & 1 000 ms, 60% reduction
Mains freq. 50 Hz	EN 61000-4-16	Signal ports	100 V 50 Hz line to earth
Mains freq. 50 Hz	SS 436 15 03	Signal ports	250 V 50 Hz line to line
Voltage dips and interruption	EN 61000-4-29	DC power ports	10 & 100 ms, interruption 10 ms, 30% reduction 10 ms, 60% reduction +20% above & -20% below rated voltage
Radiated emission	EN 55022	Enclosure	Class B
	FCC part 15		Class B
Conducted emission	EN 55022	AC power ports	Class B
	FCC part 15	AC power ports	Class B
	EN 55022	DC power ports	Class B
Dielectric strength	EN 60950	Signal port to other isolated ports	2 kVrms 50 Hz 1 min
		Power port to other isolated ports	3 kVrms 50 Hz 1 min 2 kVrms 50 Hz 1 min (@ rated power <60 V)
<b>Environmental</b>			
Temperature		Operating	-25 to +70°C
		Storage & Transport	-30 to +70°C
Humidity		Operating	5 to 95% relative humidity
		Storage & Transport	5 to 95% relative humidity
Altitude		Operating	2 000 m / 70 kPa
Service life		Operating	10 year
Vibration	IEC 60068-2-6	Operating	7.5 mm, 5 – 8 Hz 2 g, 8 – 500 Hz
Shock	IEC 60068-2-27	Operating	15 g, 11 ms
<b>Packaging</b>			
Enclosure	UL 94	PC / ABS	Flammability class V-1
Dimension W x H x D			55 x 100 x 132 mm
Weight			0.25 kg
Degree of protection	IEC 529	Enclosure	IP 20
Cooling			Convection
Mounting			Horizontal on 35 mm DIN-rail

## Description

TD-23 is designed to satisfy industry's demands on reliability and functionality in environments with high levels of interference. TD-23 communicates via a 2- or 4-wire leased line according to the V.23 standard. Equipment with an RS-232 or RS-422/485 interface can be connected and communicate point-to-point or in a multidrop application. The modem is equipped with DIP-switches to set specific functions in hardware, for example, reception sensitivity, output signal level, etc.

This is of particular importance as it allows each modem to be optimised according to the line quality. A general calculation allows 16 units over a distance of up to 25 km (15.5 miles).

TD-23 is intended for mounting on a 35 mm DIN-rail, where the modem is attached and locked in a single action.

- ⌘ Data rate 1200 bit/s (V.23)
- ⌘ 2-wire (half duplex), 4-wire (full duplex)
- ⌘ Number of multidrop points, 16 (typical value)
- ⌘ Transmission distance up to 25 km (15.5 miles)
- ⌘ Adjustable output signal level
- ⌘ Adjustable reception sensitivity
- ⌘ Transient protection on the line side
- ⌘ AC-/DC-supply
- ⌘ Galvanic isolation (line/supply)
- ⌘ Optional relay output reflecting the transmitter carrier

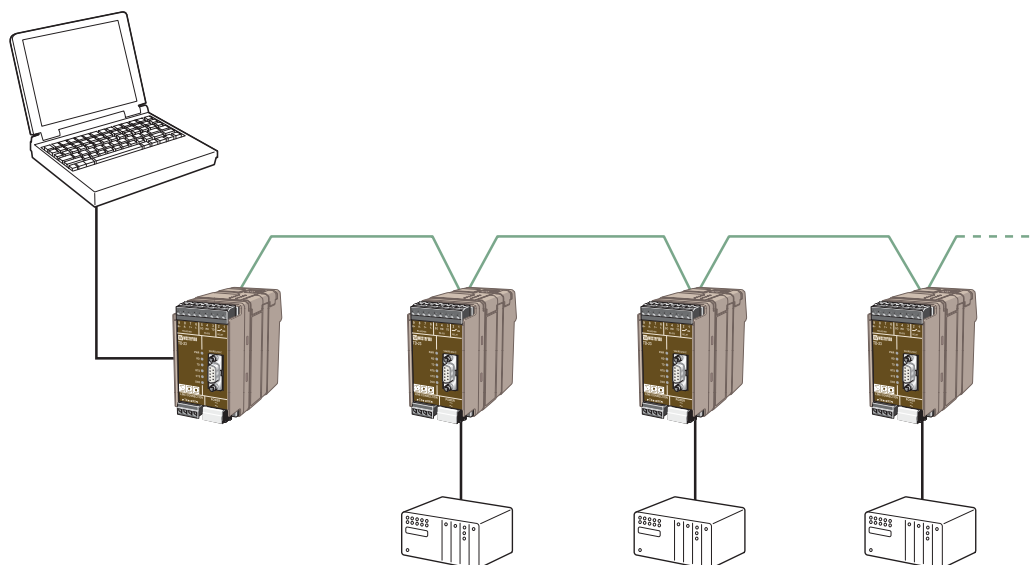

# Functional description

## Block diagram

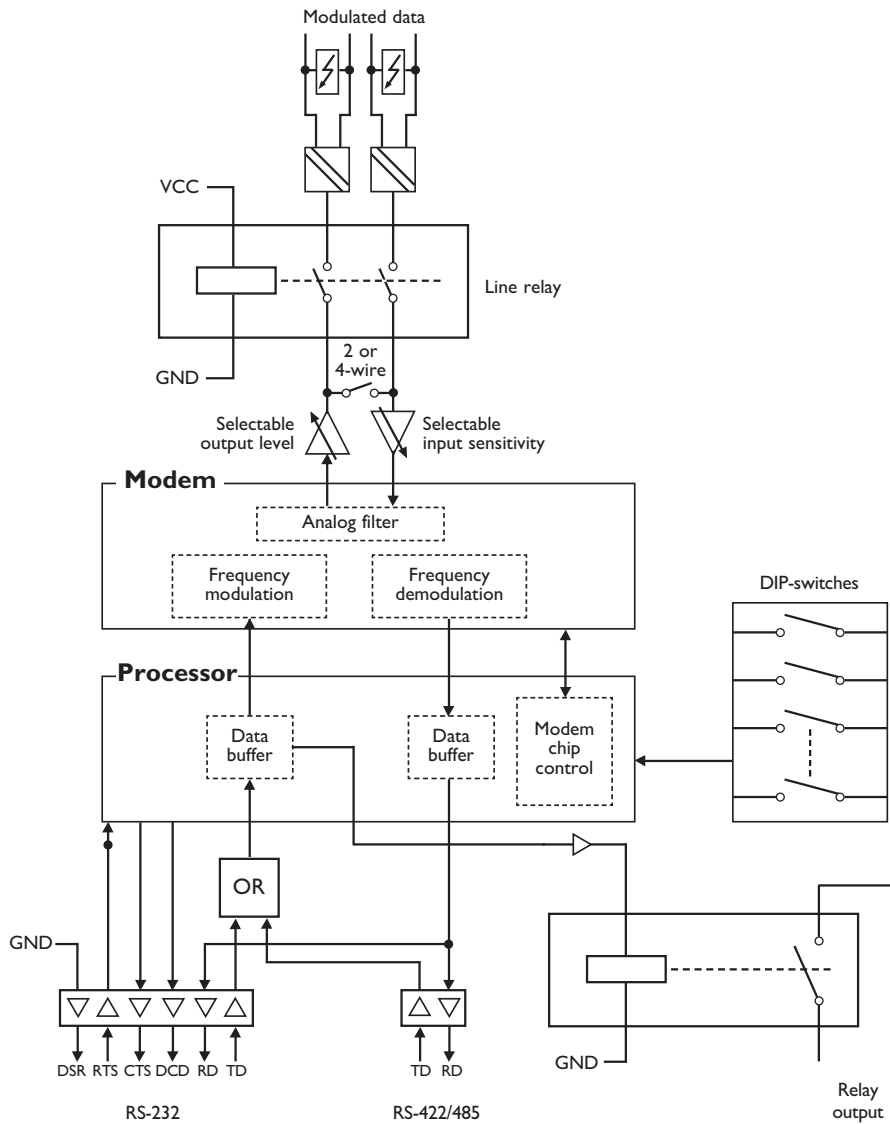



## Interface specifications

<b>Power LV</b>	
Rated voltage	12 to 48 VDC 12 to 27 VAC
Operating voltage	10 to 60 VDC 10 to 30 VAC
Rated current	125 mA @ 12 VDC 50 mA @ 24 VDC 28 mA @ 48 VDC 125 mA @ 12 VAC 50 mA @ 24 VAC 25 mA @ 32 VAC
Rated frequency	DC / AC 48 – 62 Hz
Inrush current I <sup>2</sup> t	0.09 A <sup>2</sup> s
Startup current*	0.35 A peak
Polarity	Polarity independent
Isolation to	RS-232 / RS-422/485 / Leased Line
Connection	Detachable screw terminal
Connector size	0.2 – 2.5 mm <sup>2</sup> (AWG 24-12)
Shielded cable	Not required

<b>Power HV</b>	
Rated voltage	60 to 250 VDC 95 to 240 VAC
Operating voltage	48 to 300 VDC 85.5 to 264 VAC
Rated current	10 mA @ 110 VDC 7 mA @ 250 VDC 20 mA @ 95 VAC 15 mA @ 240 VAC
Rated frequency	DC / 48 – 62 Hz
Inrush current I <sup>2</sup> t	0.05 A <sup>2</sup> s
Startup current*	0.03 A peak
Polarity	Polarity independent
Isolation to	RS-232 / RS-422/485 / Leased Line
Connection	Detachable screw terminal
Connector size	0.2 – 2.5 mm <sup>2</sup> (AWG 24-12)
Shielded cable	Not required

<b>RS-422/485</b>	
Electrical specification	EIA RS-485 2-wire or 4-wire twisted pair
Data rate	300 bit/s – 1200 bit/s
Data format	7 or 8 data bits, Odd, even or none parity, 1 or 2 stop bits, $\Sigma$ 9-12 bits
Protocol	Transparent
Retiming	No
Turn around time	4.2 ms (half duplex)
Transmission range	$\leq 1200$ m, depending on data rate and cable type (EIA RS-485)
Settings	120 $\Omega$ termination and failsafe biasing 680 $\Omega$
Protection	Installation Fault Tolerant (up to $\pm 60$ V)
Isolation to	Power / Leased Line
Connection	Detachable screw terminal
Connector size	0.2 – 2.5 mm <sup>2</sup> (AWG 24 – 12)
Shielded cable	Not required*

<b>RS-232</b>	
Electrical specification	EIA RS-232
Data rate	300 bit/s – 1200 bit/s
Data format	7 or 8 data bits, Odd, even or none parity, 1 or 2 stop bits; $\Sigma$ 9-12 bits
Protocol	Transparent
Retiming	No
Transmission range	15 m
Isolation to	Power / Leased Line
Connection	9-pin D-sub female (DCE) or Detachable screw terminal (DCE)
Connector size	0.2 – 2.5 mm <sup>2</sup> (AWG 24 – 12)
Shielded cable	Not required*
Conductive housing	Isolated to all other housings

\* Railway installation close to the rails.

For a cable located inside 3 m boundary and connected to this port, the use of shielded cable is recommended, this is to minimise the risk of interference. The cable shield should be properly connected (360°) to an earthing point within 1 m from this port. This earthing point should have a low impedance connection to the conductive enclosure of the apparatus cabinet, or similar, where the unit is built-in. This conductive enclosure should be connected to the earthing system of an installation and may be directly connected to the protective earth.

<b>Relay (optional)</b>	
Rated voltage	Up to 48 VDC
Operating voltage	Up to 60 VDC
Contact rating	50 mA @ 48 VDC
Contact resistance	8 $\Omega$
Transmission range	$\leq 3$ m, depending on data rate and cable type
Function	The output follows the transmit carrier, i.e. output shorted when carrier is ON.
Isolation to	Power, Leased Line, RS-232, RS-485/422
Connection	Detachable screw terminal
Connector size	0.2 – 2.5 mm <sup>2</sup> (AWG 24 – 12)
Shielded cable	Not required

<b>Leased Line</b>	
Electrical specification	2- or 4-wire Leased Line
Data rate	300 bit/s – 1200 bit/s
Transmission level	+3, -3, -6, -9, -10, -12, -13, -15 dBm Transmission levels above -9 dBm are not allowed on PTT networks only on private wires
Sensitivity reseption	-45, -33, -27, -23 dBm
Protocol	V23hdx, V23fdx
Turn around time	33 ms (half duplex)
Transmission range/ Budget	30dB
Protection	Installation Fault Tolerant (up to $\pm 60$ V)
Isolation to	Power / RS-232 / RS-422/485
Connection	Detachable screw terminal
Connector size	0.2 – 2.5 mm <sup>2</sup> (AWG 24 – 12)
Shielded cable	Not required

## RS-422/485

9-position	Direction*	Description	Product marking
No 9	In	R+ (A') Receive RS-422/485 4-wire	R+
No 8	In	R- (B') Receive RS-422/485 4-wire	R-
No 7	Out	T+ (A) Transmit RS-422/485 4-wire	T+
	In/Out	T+/R+ (A/A') Transmit/Receive RS-422/485 2-wire	
No 6	Out	T- (B) Transmit RS-422/485 4-wire	T-
	In/Out	T-/R- (B/B') Transmit/Receive RS-422/485 2-wire	

## RS-232 (DTE)

Position		Direction*	Description	D-sub description
D-sub	Screw terminal			
No. 1		Out	Data Carrier Detect (DCD)	
No. 2	No. 4	Out	Received Data (RD)	
No. 3	No. 3	In	Transmitted Data (TD)	
No. 4		NC	Data Terminal Ready (DTR)	
No. 5	No. 5	-	Signal Ground (SG)	
No. 6		Out	Data Set Ready (DSR)	
No. 7		In	Request To Send (RTS)	
No. 8		Out	Clear To Send (CTS)	
No. 9		NC	Ring Indicator (RI)	

\* Direction relative this unit. NC = Not Connected

### Relay (optional)

Position	Direction*	Description
No. 1	Out	Normal open
No. 2	Out	Common

### Power connection HV

Position	Direction*	Description	Product marking
L	In	AC: Neutral DC: -Voltage	~
N	In	AC: Line DC: +Voltage	
⊕	-	Not used	

### Power connection LV

Position	Direction*	Description	Product marking
No. 1	In	AC: Neutral DC: -Voltage	~
No. 2	In	AC: Line DC: +Voltage	

### Leased Line

Position	Direction*	Description	Product marking
No 1	Out	4-wire Transmit	TX
	In/Out	2-/4-wire Receive/ Transmit	
No 2	Out	4-wire Transmit	
	In/Out	2-/4-wire Receive/ Transmit	
No 3	In	4-wire Receive	RX
No 4	In	4-wire Receive	

\* Direction relative this unit

### LED Indicators

LED	Status	Description
PWR Power	ON	In service
	OFF	Out of service
RD Receive data	ON	Data transmitted on the RS-232 or RS-485 port
	OFF	No data transmitted on the RS-232 or RS-485 port
TD Transmit data	ON	Data received on the RS-232 or RS-485 port
	OFF	No data received on the RS-232 or RS-485 port
RTS Request to send	ON	RTS signal active on the RS-232 port
	OFF	RTS signal inactive on the RS-232 port
CTS Clear to send	ON	CTS signal active on the RS-232 port
	OFF	CTS signal inactive on the RS-232 port
DCD Data carrier detect	ON	DCD signal active on the RS-232 port
	OFF	DCD signal inactive on the RS-232 port

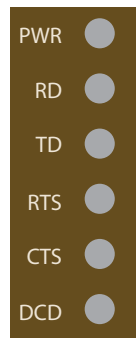

## DIP-switch settings



### Before DIP-switch settings:

Prevent damage to internal electronics from electrostatic discharges (ESD) by discharging your body to a grounding point (e.g. use of wrist strap).

**NOTE** DIP-switch alterations are only effective after a power on.

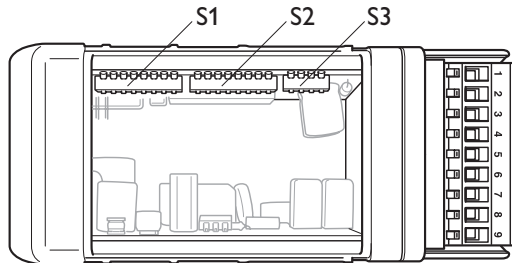

### S1 DIP-switch

#### Selection of transmission level



3 dBm



-9 dBm

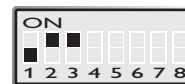

-13 dBm

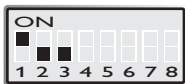

-3 dBm



-10 dBm



-15 dBm

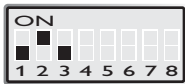

-6 dBm

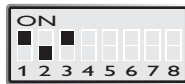

-12 dBm

Selection of transmission level specifies the maximum output power level. The maximum value is 3 dBm. By selecting the higher transmission levels communication over longer distances can be achieved, but the noise and disturbance levels will increase. We recommend that you try your system with the factory default setting first. If disturbances are detected (faulty characters or other errors) decrease the power level step by step. If the transmission fails because of a weak signal the transmission level can be increased step by step until a satisfactory transmission quality is achieved. Please note that levels above -9 dBm are not allowed on PTT networks and can only be used on private wires!

## S1 DIP-switch

### Selection of minimum level detection DCD

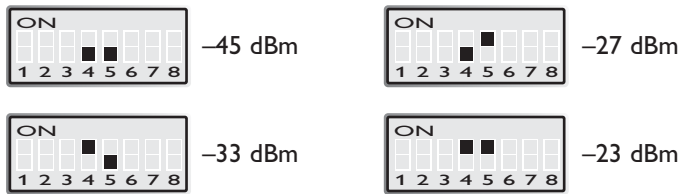

Selection of minimum level, DCD detection specifies the minimum power level the receiver can handle. With the receiver having a dynamic range of 30 dBm, this means that with the level set to  $-15$  dBm the TD-23 will pick up signals in the range  $-15$  dBm to  $-45$  dBm. We recommend that you try your network with the factory settings. If disturbances are detected (faulty characters or other errors) decrease the level step by step. If there is no communication because of a weak signal the receiver sensitivity can be increased step by step until satisfactory transmission quality is achieved.

## S1 DIP-switch

### 2 or 4 Wire Line side



## S1 DIP-switch

### Carrier active using RTS or incoming data



If the DTE uses the control signal- (RTS) the RTS signal is used to activate the transmitter. If the DTE does not control RTS or if RS-485 is used then the transmitter is activated by incoming data. In this case the data is buffered in the TD-23 while the carrier is established. By setting RTS always active a permanent carrier will be established. This is the typical setting for a full duplex 4-wire communication.

**S2 DIP-switch**  
**Selection of 2/4 wire RS-422/485 side**



2-wire

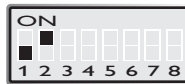

4-wire

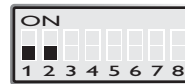

Deactivate  
RS-422/485

All RS-422/485 lines should be terminated at the end-points. The RS-422/485 interface also has a fail-safe circuit which forces a non-active line into idle state.

**S2 DIP-switch**  
**RTS-CTS delay, 23 or 60 ms**



60 ms



23 ms

When a 23 ms delay is chosen, the modem can handle the normal RTS-CTS behaviour as well as handle that TxD data is received before the 23 ms delay has elapsed. If TxD data is received before the modem has activated the CTS signal, the data is buffered. The time the data is delayed depends on how long after the activation of the RTS the first data bit is received. If a delay of 60 ms is chosen, all data received from the DTE interface (TxD) before the modem has activated the CTS signal is ignored.

**S2 DIP-switch**  
**Termination of the line**



No  
termination

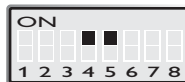

Termination

The line should be terminated at the end-points.  
 S2:6 Not used.

**S2 DIP-switch**  
**Activity timer**

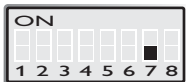

Off

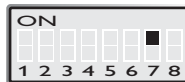

On 1 min

The use of the timer is a fail safe to ensure that a faulty unit connected to the modem will not block the line.  
 S2:6 Not used.

**S2 DIP-switch**  
**Filtering of DCD and RXD**



Off

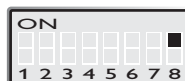

On

If this is enabled, RxD is delayed (buffered) 6 ms in order to avoid garbage characters when carrier is deactivated. The turn around time for the modem from sending to receiving on the line is 10 ms if this filter is enabled.



### S3 DIP-switch

#### RS-422/485 termination



No termination  
or failsafe



2-wire termination with  
failsafe; T+/R+ and T-/R-



4-wire termination with failsafe;  
T+ and T-, R+ and R-

#### Factory settings



S1

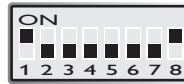

S2



S3

## RS-422/485 general advice

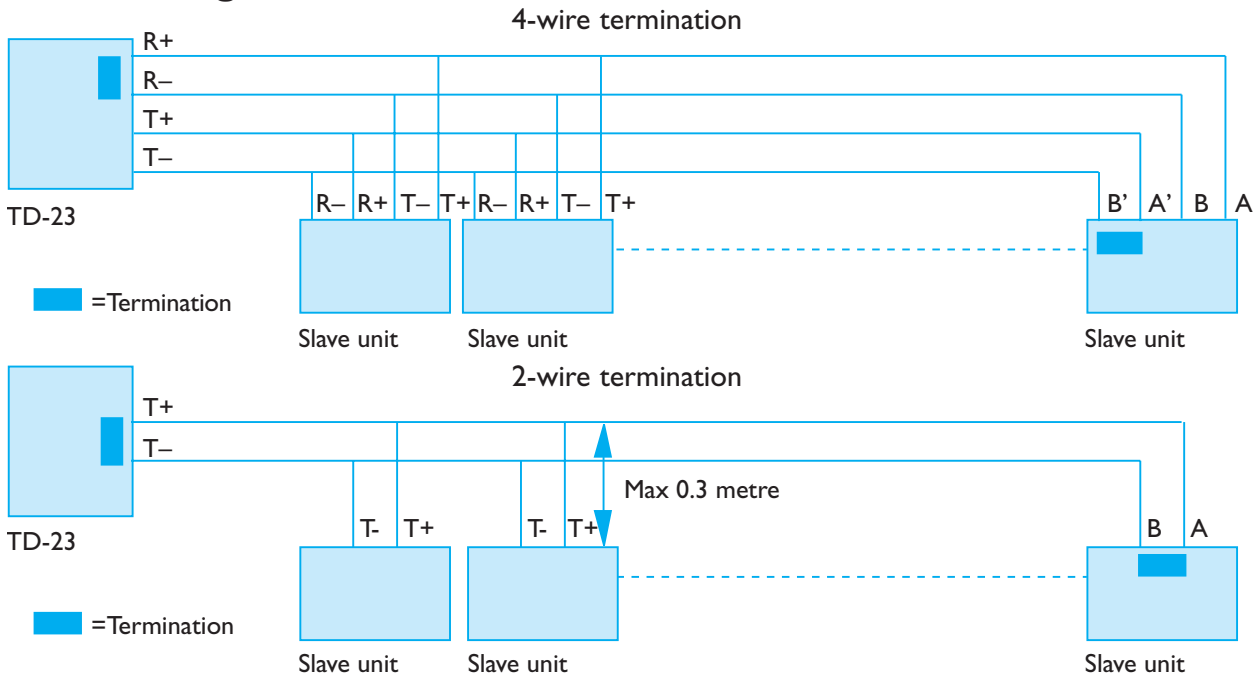

### Termination recommendations

The RS-422/485 line must be terminated. In the TD-23 the termination is combined with fail-safe functionality. For that reason it is important that the termination is used not to get undefined states when the bus is in three state condition.

- ⌘ At 2-wire RS-485 both ends shall be terminated at the other most units of the bus.
- ⌘ At 4-wire RS-485 both pairs shall be terminated at both ends.
- ⌘ At 4-wire RS-422 it is only necessary to terminate the receivers.

RS-422/485 connection pins can be differently named. For some brands the T+ corresponds to A, but other brands might use some other naming convention. If a unit does not work it can help to swap A and B.

## Mounting

This unit should be mounted on 35 mm DIN-rail, which is horizontally mounted inside an apparatus cabinet, or similar. Snap on mounting, see figure.

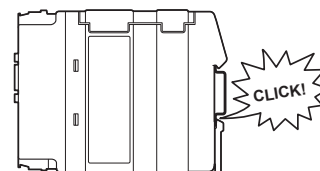
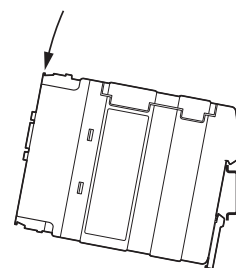

## Cooling

This unit uses convection cooling. To avoid obstructing the airflow around the unit, use the following spacing rules. Minimum spacing 25 mm (1.0 inch) above /below and 10 mm (0.4 inches) left /right the unit. Spacing is recommended for the use of unit in full operating temperature range and service life.

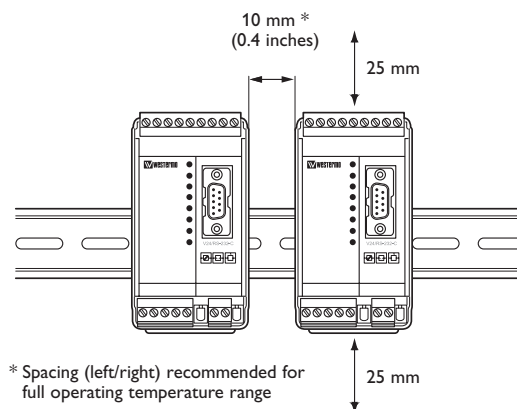

## Removal

Press down the black support at the back of the unit using a screwdriver, see figure.

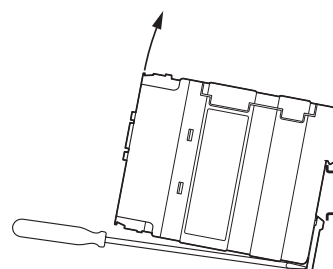
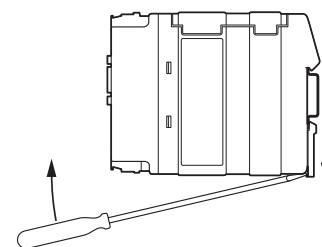

# Application examples

## RS-232, 2-wire connection

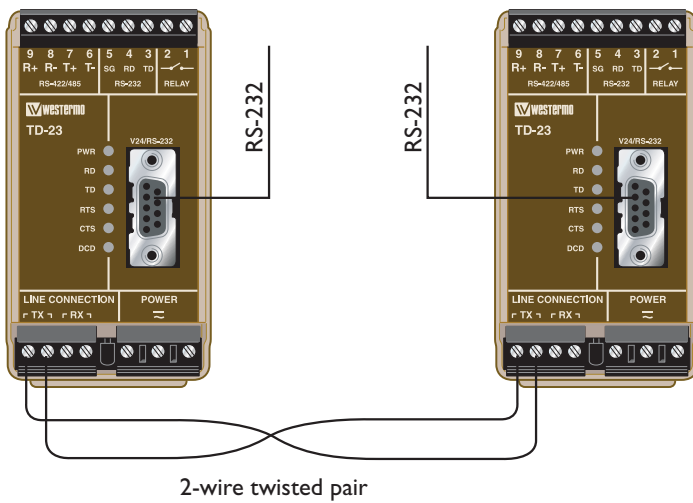

DIP-switch setting for both units



# Multidrop application

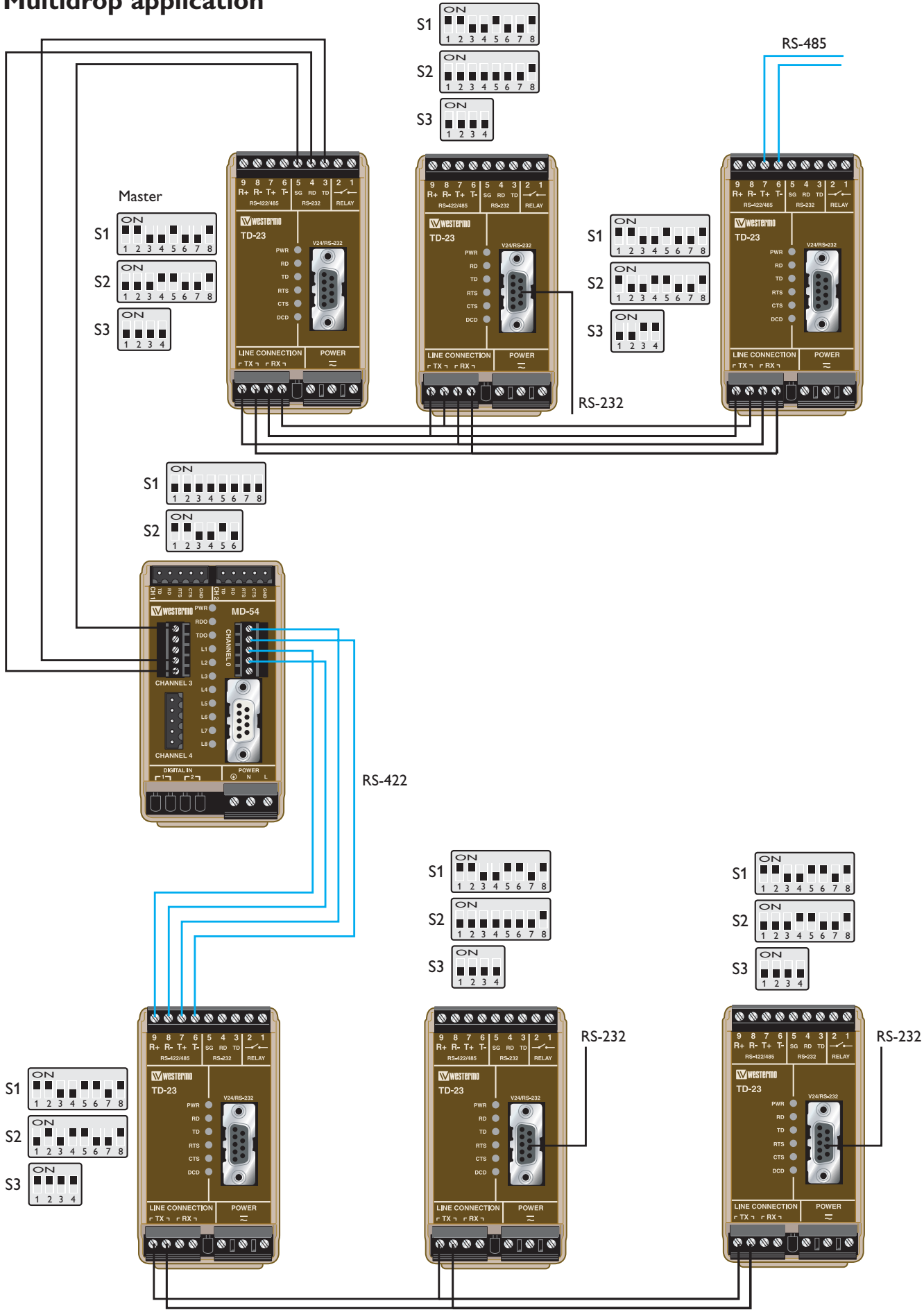







Westermo Teleindustri AB • SE-640 40 Stora Sundby, Sweden

Phone +46 16 42 80 00 Fax +46 16 42 80 01

E-mail: [info@westermo.se](mailto:info@westermo.se)

**Westermo Web site: [www.westermo.com](http://www.westermo.com)**

---

### Subsidiaries

---

Westermo OnTime AS  
Gladsvei 20 0489 Oslo, Norway  
Phone +47 22 09 03 03 • Fax +47 22 09 03 10  
E-mail: [contact@ontimenet.com](mailto:contact@ontimenet.com)

Westermo Data Communications Ltd  
Talisman Business Centre • Duncan Road  
Park Gate, Southampton • SO31 7GA  
Phone: +44(0)1489 580 585 • Fax.:+44(0)1489 580586  
E-Mail: [sales@westermo.co.uk](mailto:sales@westermo.co.uk)

Westermo Data Communications GmbH  
Goethestraße 67, 68753 Waghäusel  
Tel.: +49(0)7254-95400-0 • Fax.:+49(0)7254-95400-9  
E-Mail: [info@westermo.de](mailto:info@westermo.de)

Westermo Data Communications S.A.R.L.  
9 Chemin de Chilly 91160 CHAMPLAN  
Tél : +33 1 69 10 21 00 • Fax : +33 1 69 10 21 01  
E-mail : [infos@westermo.fr](mailto:infos@westermo.fr)

*Westermo Teleindustri AB have distributors in several countries, contact us for further information.*