

# RT-220-HV / RT-220-LV User Guide





## Version History

Version	Date	Comments
A	2019-09	First version

### License and copyright for included Free/Libre Open Source Software

This product includes software developed by third parties, including Free/Libre Open Source Software (FLOSS). The specific license terms and copyright associated with the software are included in each software package respectively. Please visit the product homepage for more information.

Upon request, the applicable source code will be provided. A nominal fee may be charged to cover shipping and media. Please direct any source code request to your normal sales or support channel.

# Table of Contents

<b>1 Foreword</b> .....	<b>6</b>
1.1 Legal information .....	6
1.2 References and related documents .....	6
1.3 Abbreviations and Terms.....	6
<b>2 RT-220 Introduction</b> .....	<b>8</b>
2.1 Supported Product Versions, Variants and SW .....	9
2.2 Important Safety Notes.....	9
2.3 RT-220 Delivery Content.....	10
2.4 Installation Countries .....	10
2.5 Regulatory Notices .....	11
2.5.1 United States (FCC) .....	11
2.5.2 Canada (IC) .....	11
2.5.3 Certified Antennas for FCC and IC .....	12
2.6 Output power limitations .....	12
2.7 Product Identification and Version Information .....	13
<b>3 Installation</b> .....	<b>15</b>
3.1 Installation Procedure, Overview.....	15
3.2 Dimensions for Fixing Points .....	16
3.2.1 Mechanical Overview .....	16
3.2.2 Mechanical Integration, Fixing Points and Connector Positions .....	18
3.3 Considerations When Mounting the Device .....	19
3.3.1 General Installation Considerations .....	19
3.3.2 Temperature Alarms.....	19
3.3.3 Ambient Operating Temperature Range .....	19
3.3.4 Installations at Very High Temperatures .....	20
3.4 Connecting the Protective Earth.....	22
3.5 Connecting the RF Antenna Interfaces .....	22
3.5.1 RF Antenna Interface Operation Modes .....	22
3.5.2 RF Antenna Connectors.....	23
3.6 Connecting Ethernet Interface.....	24
3.6.1 Ethernet Port Features .....	24
3.6.2 Ethernet Connector .....	25
3.6.3 PoE Connection (X1 and RT-220-LV only) .....	25
3.6.4 PoE Power Feed Specifications .....	25
3.7 Connecting the Power Feed.....	26
3.7.1 Power Feed Connector .....	26
3.7.2 Power Feed Specifications.....	27
3.7.3 Power supply ripple .....	27
<b>4 Configuration and Use</b> .....	<b>28</b>
4.1 LED Indicators During Power Up Sequence .....	28
4.2 Factory Reset Interface, Process for Factory Reset .....	28
4.2.1 Factory Reset Adapter Specification .....	29
4.2.2 Factory Reset Procedure .....	29
<b>5 Maintenance</b> .....	<b>30</b>
5.1 Cleaning– Resistance to Chemicals.....	30
5.2 Troubleshooting Based on Functional Behavior .....	31
5.3 Repair Work.....	31
5.3.1 Exchange of the Product.....	31

## Figures and Tables

Figure 1 RT-220-LV Picture.....	8
Figure 2 RT-220-HV / RT-220-LV Block diagram.....	8
Figure 3 RT-220-LV Product identification label position .....	13
Figure 4 RT-220 Product identification label example.....	13
Figure 5 RT-220 Product label example.....	14
Figure 6 Mechanical overview .....	16
Figure 7 Connectors .....	18
Figure 8 Installation with blocked airflow shall be avoided.....	20
Figure 9 Installation with free airflow - good installation.....	20
Figure 10 Improved heat transfer based on fixing plate .....	21
Figure 11 Grounding contact .....	22
Figure 12 Antenna interfaces .....	23
Figure 13 Ethernet interfaces .....	24
Figure 14 RT-220, power connector.....	26
Figure 15 Power, operation, status and Ethernet LEDs .....	28
Figure 16 Ethernet Port for Factory Reset .....	28
Figure 17 Factory reset plug D-coded.....	29
Table 1 Supported product versions, variants and SW .....	9
Table 2 Important safety notes .....	9
Table 3 RT-220-xx delivery content.....	10
Table 4 Installation countries.....	10
Table 5 FCC and IC certified antennas .....	12
Table 6 Output power limitations .....	12
Table 7 Product Identification Label .....	13
Table 8 Product label explanation .....	14
Table 9 Installation procedure .....	15
Table 10 Dimensions and weight .....	17
Table 11 Fixing points and connector positions .....	18
Table 12 RF Antenna interface operation .....	22
Table 13 Pinning: RF antenna connector .....	23
Table 14 Ethernet port features.....	24
Table 15 Ethernet connector .....	25
Table 16 PoE connection .....	25
Table 17 PoE power feed specifications .....	25
Table 18 Pinning: PWR connector .....	26
Table 19 Power feed specifications.....	27
Table 20 Factory reset procedure .....	29
Table 21 Exchange flow .....	31

# 1 Foreword

This document describes the installation procedure of the RT-220-HV and RT-220-LV devices.

## 1.1 Legal information

The contents of this document are provided “as is”. Except as required by applicable law, no warranties of any kind are made in relation to the accuracy and reliability or contents of this document, either expressed or implied, including but not limited to the implied warranties of merchantability and fitness for a particular purpose. Westermo reserves the right to revise this document or withdraw it at any time without prior notice.

Under no circumstances shall Westermo be responsible for any loss of data or income or any special, incidental, and consequential or indirect damages howsoever caused.

More information about Westermo can be found at [www.westermo.com](http://www.westermo.com).

## 1.2 References and related documents

No.	Title
[1]	Software 6 Management Guide
[2]	RT-220-HV Datasheet
[3]	RT-220-LV Datasheet

Further information about the product and relevant software tools can be downloaded from the product support pages at [www.westermo.com/support/product-support](http://www.westermo.com/support/product-support).

## 1.3 Abbreviations and Terms

Abbreviation	Description
CE	Conformité Européenne
DC	Direct Current
ESD	Electro Static Discharge
ETSI	European Telecommunications Standards Institute
FCC	Federal Communication Commission
IC	Industry Canada
ID	Identification
IP	Ingress Protection
ISO	International Standardization Organisation
LED	Light Emitting Diode
PoE	Power over Ethernet
RF	Radio Frequency
SN	Serial Number

SNMP	Simple Network Management Protocol
WebGUI	Web Graphical User Interface
WLAN	Wireless Local Area Network

## 2 RT-220 Introduction

The RT-220 is a wireless communication product, developed for demanding industrial and railway applications. It is a radio device operating at 2.4 and 5 GHz WLAN bands, and configured either as Access Point or Station.

The Westermo configuration management tool, WeConfig, can be used for discovery and basic configuration and maintenance. The configuration can be done via SNMP or via WebGUI. The status information is available in local LED status indicators, and through SNMP/WebGUI.



Figure 1 RT-220-LV Picture

The product functional block diagram is shown in Figure 2.

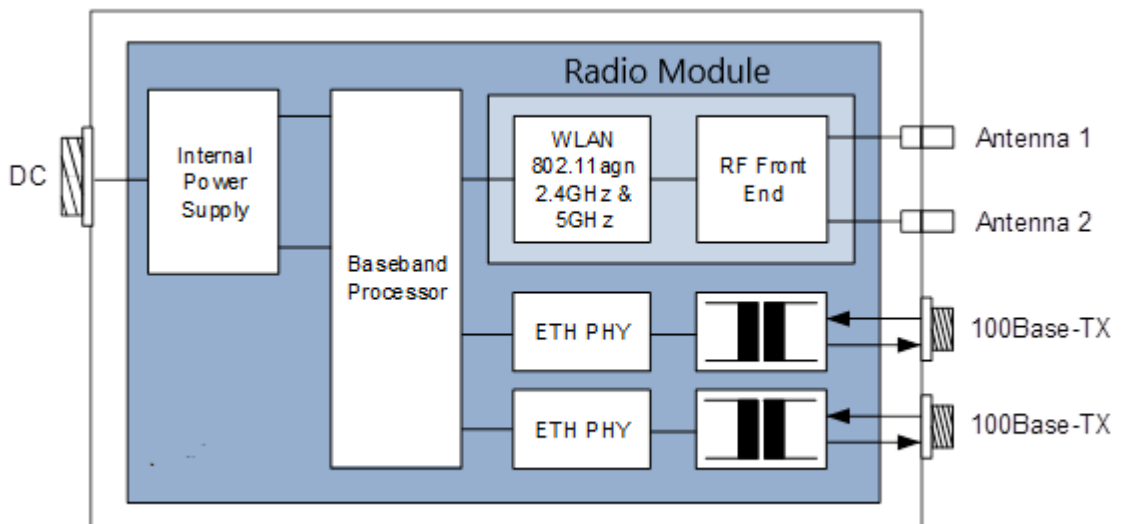


Figure 2 RT-220-HV / RT-220-LV Block diagram



## 2.1 Supported Product Versions, Variants and SW

Supported product versions, variants and SW:

<b>Specification</b>	<b>Value</b>	<b>Notes</b>
<b>Product Versions/ Variants</b>	<b>RT-220-LV</b>	<i>24V DC / PoE variant</i>
	<b>RT-220-HV</b>	<i>72-110V variant</i>
<b>Software Version</b>	<b>V6.8.7 and higher</b>	

Table 1 Supported product versions, variants and SW

## 2.2 Important Safety Notes








	<p><b>Danger!</b></p> <p>Do not use equipment without protective earth connection.</p>
	<p><b>Danger!</b></p> <p>Do not use damaged equipment and/or accessories such as damaged power cord.</p>
	<p><b>Danger!</b></p> <p>Never try to open the device. There are no serviceable parts inside. By trying to open the device you will be exposed to a risk of death or injury.</p>
	<p><b>Warning!</b></p> <p>Product warranty gets void and any liability will be disclaimed when opening the device.</p>
	<p><b>Warning!</b></p> <p>Read this user guide carefully before mounting, installing and operating the device.</p>
	<p><b>Warning!</b></p> <p>Never unplug equipment from the electrical outlet by holding the cord only, always disconnect the cable by applying force directly to the plug.</p>
	<p><b>Warning!</b></p> <p>Do not operate the device in any other environmental conditions than it is designed for.</p>

Table 2 Important safety notes

## 2.3 RT-220 Delivery Content

The RT-220 delivery consists of following main components:

<b>Description</b>	<b>Number of Parts</b>	<b>Notes</b>
<b>RT-220-xx</b>	<b>1</b>	
<b>Connector Dust Cap</b>	<b>5</b>	<i>Temporary protection of connectors:</i> <ul style="list-style-type: none"> <li>• 2 plastic protection caps for Ethernet connectors</li> <li>• 1 plastic protection cap for power connector</li> <li>• 2 plastic protection caps for antenna connectors</li> </ul>

**Table 3** RT-220-xx delivery content

## 2.4 Installation Countries

Installation country regulatory limits and operating parameters are controlled by Software Country Code parameter. This product supports:

<b>Country Code</b>	<b>Operating Frequency Ranges</b>	<b>Notes</b>
<b>Europe (EU)</b>	<b>2412 ... 2472 MHz and 5180 ... 5320 MHz, 5500 ... 5700 MHz</b>	<i>Operation according to ETSI limitations For detailed specification, refer to document Software 6 Management Guide [1]</i>
<b>United States (USA)</b>	<b>2412 ... 2472 MHz and 5180 ... 5320 MHz, 5500 ... 5700 MHz 5725 ... 5850 MHz</b>	<i>Operation according to FCC limitations For detailed specification, refer document Software 6 Management Guide [1]</i>
<b>Canada (CANADA)</b>	<b>2412 ... 2472 MHz and 5180 ... 5320 MHz, 5500 ... 5700 MHz 5725 ... 5850 MHz</b>	<i>Operation according to IC limitations For detailed specification, refer to document Software 6 Management Guide [1]</i>

**Table 4** Installation countries

**Note:** Further Software releases might support additional country codes, for up-to-date country code specification refer to document Software 6 Management Guide [1]

## 2.5 Regulatory Notices

### Caution!

Any changes or modifications shall be approved by the party responsible for compliance. If not, users could void the user's authority to operate the equipment.

Country code and antenna gain needs to be set properly for correct functionality in the installed country.

### 2.5.1 United States (FCC)

The enclosed device complies with Part 15 of the FCC Rules. Operation is subject to the following two conditions: (i.) this device may not cause harmful interference and (ii.) this device must accept any interference received, including interference that may cause undesired operation.

Contains FCC ID: **2AEJD-103902-DT50RF**

#### RF Exposure requirements:

To satisfy FCC RF exposure requirements for mobile transmitting devices, a separation distance of 20 cm or more should be maintained between the antenna of this device and persons during operation. To ensure compliance, operations at closer distances than this are not recommended.

#### Antennas:

The device can operate with the antennas listed in 2.5.3.

#### Part 15B statement:

Note: This equipment has been tested and found to comply with the limits for a Class B digital device, pursuant to part 15 of the FCC Rules. These limits are designed to provide reasonable protection against harmful interference in a residential installation. This equipment generates, uses and can radiate radio frequency energy and, if not installed and used in accordance with the instructions, may cause harmful interference to radio communications. However, there is no guarantee that interference will not occur in a particular installation. If this equipment does cause harmful interference to radio or television reception, which can be determined by turning the equipment off and on, the user is encouraged to try to correct the interference by one or more of the following measures:

- Reorient or relocate the receiving antenna.
- Increase the separation between the equipment and receiver.
- Connect the equipment into an outlet on a circuit different from that to which the receiver is connected.
- Consult the dealer or an experienced radio/TV technician for help.

### 2.5.2 Canada (IC)

This device complies with Industry Canada's license-exempt RSSs. Operation is subject to the following two conditions:

1. This device may not cause interference.
2. This device must accept any interference, including interference that may cause undesired operation of the device.

Le présent appareil est conforme aux CNR d'Industrie Canada applicables aux appareils radio exempts de licence. L'exploitation est autorisée aux deux conditions suivantes:

1. l'appareil ne doit pas produire de brouillage.
2. l'utilisateur de l'appareil doit accepter tout brouillage radioélectrique subi, même si le brouillage est susceptible d'en compromettre le fonctionnement.

IC Certification Number of the implemented WLAN communication module: **9301A-103902DT50**

#### Antennas:

The device can operate with the antennas listed in 2.5.3.

### 2.5.3 Certified Antennas for FCC and IC

The following antennas can be used with the device (the antenna type ID has to be set to the right value):

<i>Type</i>	<i>Part number</i>	<i>Manufacturer</i>	<i>Gain</i>	<i>Chains</i>	<i>Antenna Type ID</i>
Dipole	F51-N	Tekfun	2 GHz: 4.5 dBi max 5 GHz: 7 dBi max	1, 2	1001
Patch	SPA 2400/75/8/0/V	Huber & Suhner	2 GHz: 7.5 dBi max	1, 2	1000
Patch	SPA-5600/40/14/0/V_2	Huber & Suhner	5 GHz: 14 dBi max	1, 2	1002
Patch	SPA-5600/65/9/0/MIMO	Huber & Suhner	5 GHz: 9 dBi max	1, 2	1003
Shark	SPA-5600/45/12/10/V	Huber & Suhner	5 GHz: 12 dBi max	1, 2	1004

**Table 5 FCC and IC certified antennas**

### 2.6 Output power limitations

The RT-220 have following output power limitations for ambient temperatures from -40°C to +70°C.

<b>Active antennas</b>	<b>Max. output power with DC supply</b>	<b>Max. output power with PoE supply</b>
1	12dBm (2.4G) / 15dBm (5G) per chain	12dBm / 15dBm per chain
2	12dBm / 15dBm per chain	12dBm / 15dBm per chain

**Table 6 Output power limitations**

## 2.7 Product Identification and Version Information

Product identification information is available at the product label. The product label is fixed to the device.

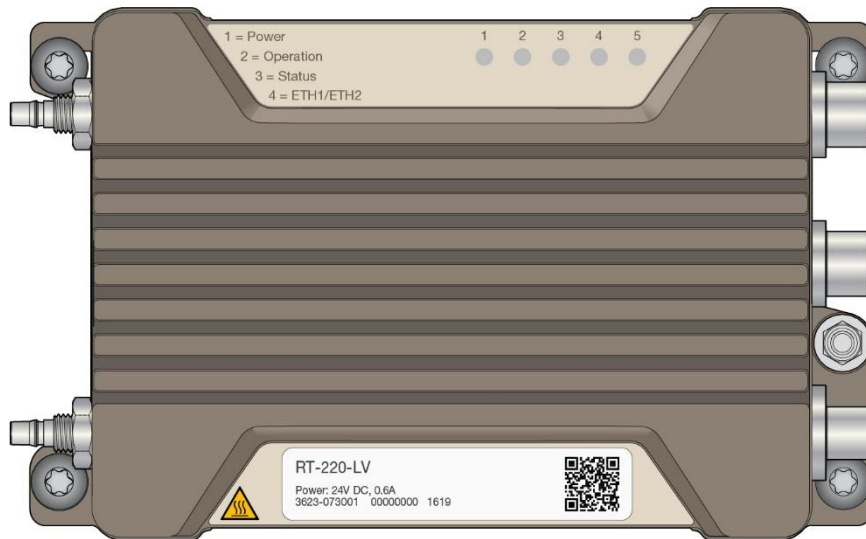


Figure 3 RT-220-LV Product identification label position

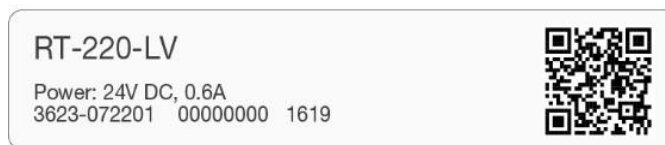


Figure 4 RT-220 Product identification label example


Specification	Value	Notes
<b>Product Name</b>	<b>RT-220-HV</b> <b>RT-220-LV</b>	Depending on voltage variant
<b>Part Number</b>	<b>3623-072301 (RT-220-HV EU)</b> <b>3623-072201 (RT-220-LV EU)</b> <b>3623-072302 (RT-220-HV NA)</b> <b>3623-072202 (RT-220-LV NA)</b>	Westermo part number
<b>SN</b>	<b>XXXXXXXX</b>	Internal serial number
<b>Manufacturing Date</b>	<b>YYWW</b>	The date format is: YY = manufacturing year WW = manufacturing week
<b>BAR CODE</b>	<b>SN information</b>	Data matrix
<b>Hot surfaces</b>		Surface temperature can be above 60°C

Table 7 Product Identification Label

At the rear side of the product further product specific information is printed to a second label.

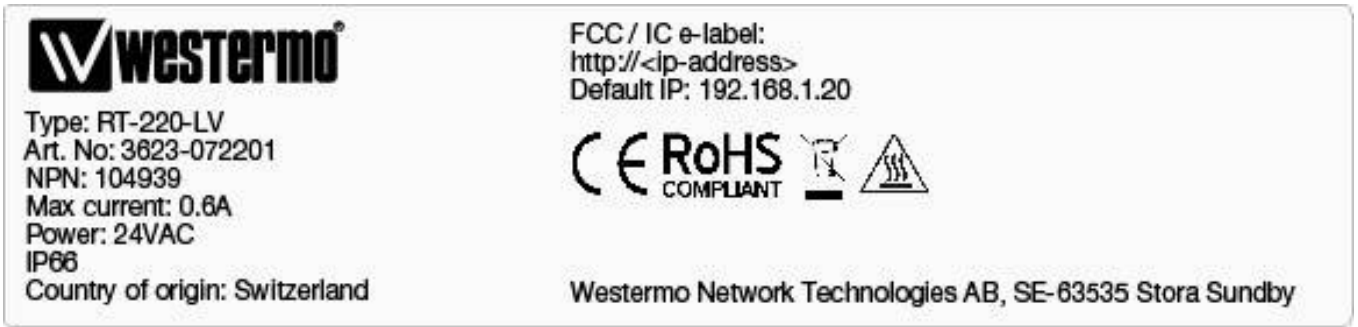


Figure 5 RT-220 Product label example

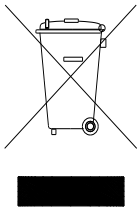

Specification	Value	Notes
<b>WEEE</b>		<p>This symbol means that the product shall not be treated as unsorted municipal waste when disposing of it. It needs to be handed over to an applicable collection point for recycling electrical and electronic equipment.</p> <p>By ensuring this product is disposed of correctly, you will help to reduce hazardous substances and prevent potential negative consequences to both environment and human health, which could be caused by inappropriate disposal.</p>
<b>Hot surfaces</b>		<p>Surface temperature can be above 60°C.</p>

Table 8 Product label explanation

## 3 Installation

### 3.1 Installation Procedure, Overview

<b><i>Order of Installation Step</i></b>	<b><i>Description</i></b>
<b>1. Fixing</b>	The product is fixed in operating environment, ensuring that the environment complies with the installation environment constrains. See chapter 3.2
<b>2. System Grounding</b>	The system grounding is ensured and verified based on customer installation. See chapter 3.4
<b>3. Antennas</b>	The antenna interfaces are installed based on customer requirements. See chapter 3.5
<b>4. Ethernet</b>	The Ethernet data interfaces are installed. See chapter 3.6
<b>5. Power Feed</b>	Power feed cable is connected (the power may be already activated in the cable), the power supply is switched on and verify that the LED indicators shows correct power up procedure. See chapter 3.7 and 4.1.
<b>6. Configuration</b>	The configuration process is described in reference document Software Management Guide chapter: Configuration.

**Table 9 Installation procedure**

### 3.2 Dimensions for Fixing Points

#### 3.2.1 Mechanical Overview

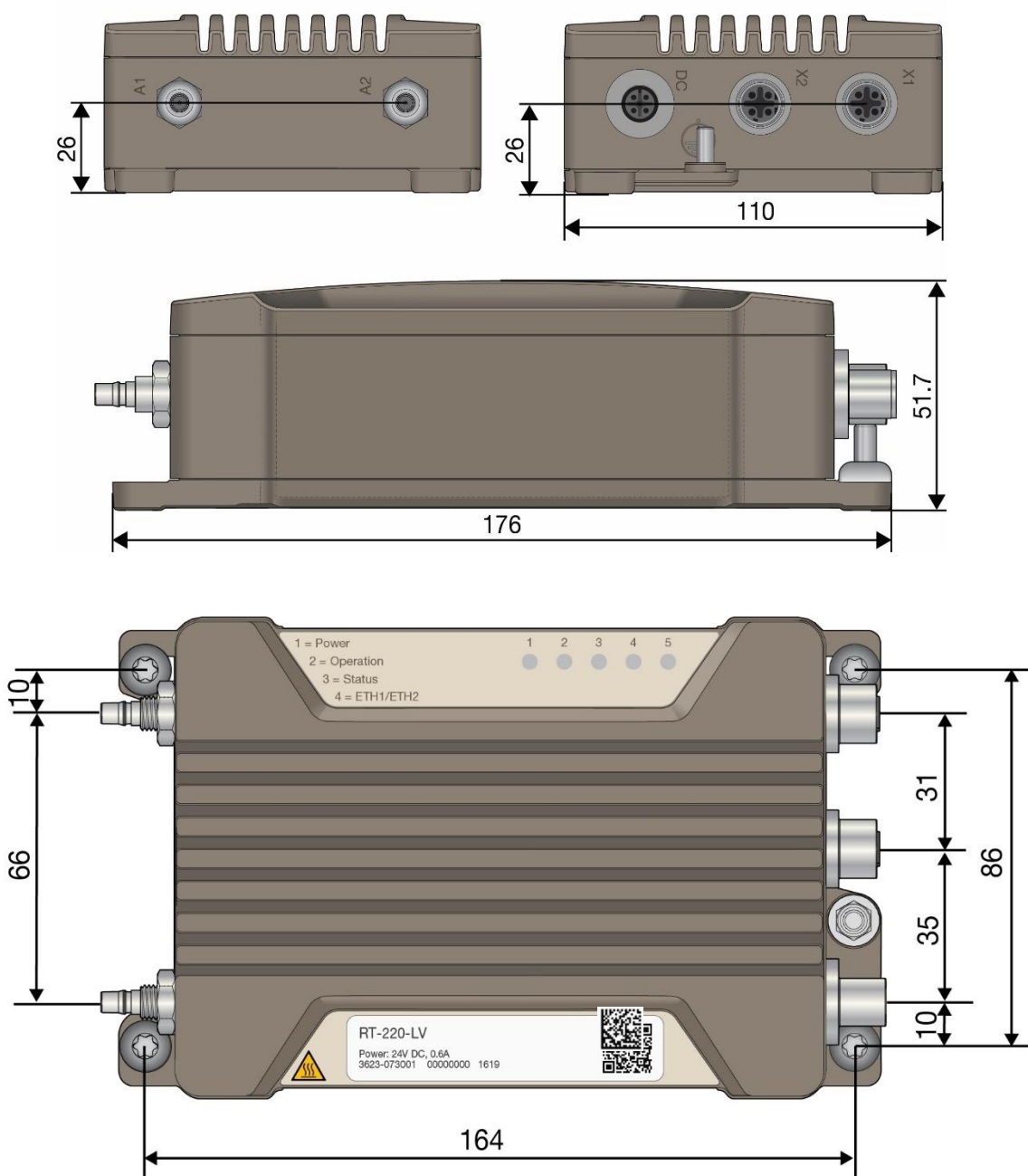


Figure 6 Mechanical overview



<b>Parameter</b>	<b>Value</b>	<b>Notes</b>
<b>Maximum dimensions</b>	176 x 110 x 52 mm	Length with antenna connectors 180mm
<b>Maximum dimensions, with cables but not including antennas</b>	Approx 300 x 110 x 52 mm	Space needed for installation
<b>Location of the fixing points</b>	In each corner	With four M6 screws
<b>Color</b>	RAL 7006, beige grey	Powder Coating
<b>Protection</b>	IP66	
<b>Weight</b>	1.1 kg	

Table 10 Dimensions and weight

### 3.2.2 Mechanical Integration, Fixing Points and Connector Positions

The product must be fixed with the four fixing points located at the corners of the product. M6 screws shall be used for the fixation of the product. The screws shall be tightened with min. 3.0 Nm (fixing screw ISO 898/1, quality class 8.8).

**NOTICE:** All four specified fixing points must be used for fixing. The fixing surface should be flat to have all fixing points connected to the surface.

The product has a membrane vent at the connector side of the product for equalizing pressure changes.

**NOTICE:** The vent does not require any maintenance. Any manipulations at the vent are not allowed.

Specification	Value				
<b>Fixing holes positions</b>	<b>Fixing holes without threads, for 6mm screws: four pieces of slot holes, see: Figure 6</b>				
	0 mm, 0 mm		164 mm, 0 mm		
	0 mm, 86 mm		164 mm, 86 mm		
<b>Connector positions</b>	<b>DC POWER</b>	<b>Antenna 1</b>	<b>Antenna 2</b>	<b>100Base-T X1<sup>1</sup></b>	<b>100Base-T X2</b>
	See Figure 7 Figure 14	See Figure 7 Figure 12	See Figure 7 Figure 12	See Figure 7 Figure 13	See Figure 7 Figure 13
<b>Grounding</b>	See Figure 7, Figure 11				

Table 11 Fixing points and connector positions

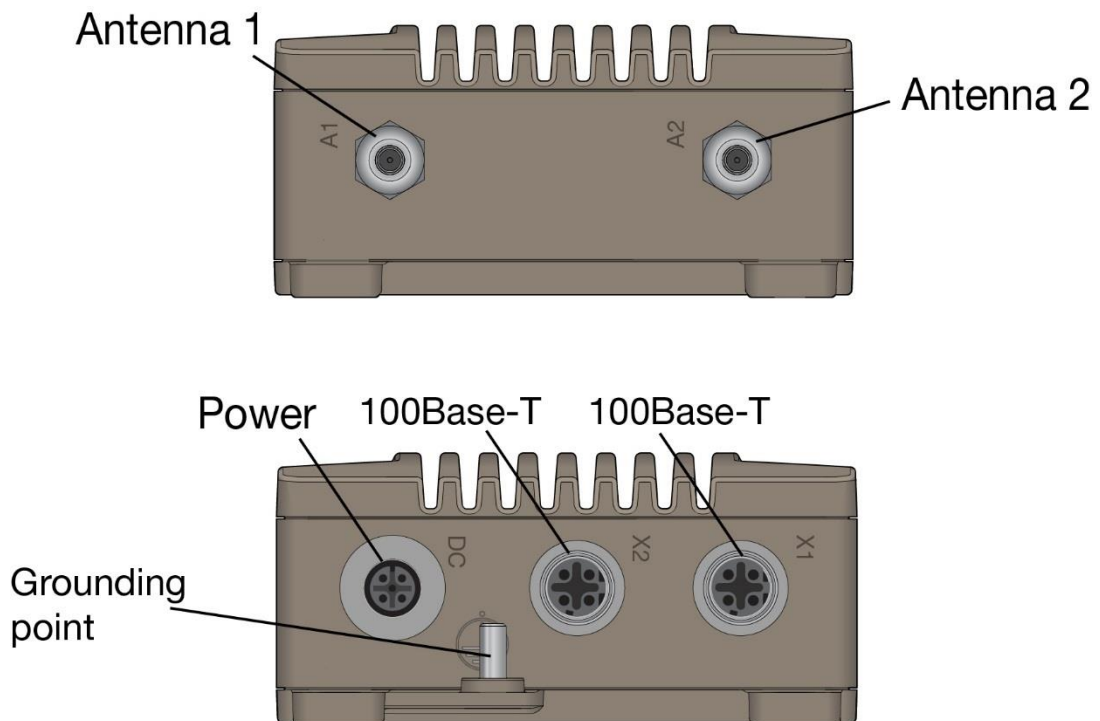


Figure 7 Connectors

<sup>1</sup> PoE for RT-220-LV only

## 3.3 Considerations When Mounting the Device

### 3.3.1 General Installation Considerations

When planning an installation at least the following points shall be considered:

- Indoor: protecting for dust (to ensure heat dissipation), vandalism, animals (rats, birds etc)
- Outdoor: protecting for sun (to optimize ambient temperature range), dust, dirt, vandalism etc.

### 3.3.2 Temperature Alarms

This product has integrated temperature sensors for monitoring the internal device temperature. The limits for the sensors are set so, that operation without alarm is ensured for ambient temperatures as specified for the product assuming correct installation.

**NOTICE:** The limits have been set so that some of the components are close to the limit of the specified temperature range. For this reason the unit shall not be operated in conditions where the temperature alarm is activated.

### 3.3.3 Ambient Operating Temperature Range

This product includes a vent allowing controlled air exchange due to temperature changes. Humidity is blocked by the vent.

To ensure correct operation over the whole specified temperature range, certain aspects need to be considered.

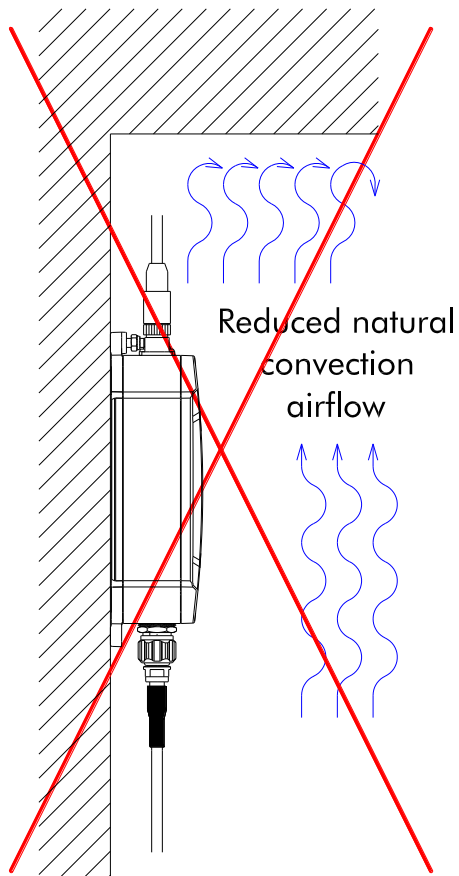
The limits are defined for installations with free air flow in the installation environment.

It shall be noted that in real environment:

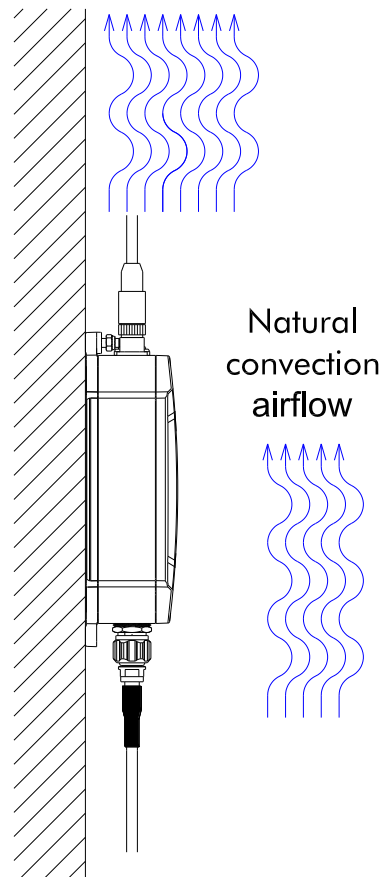
- Limited air flow is rising the device temperature and may lower the upper limit of the operating temperature range
- Conducted heat exchange through metal surfaces at the product fixing point is improving the device heat transfer and improving the operating conditions
- Temperature is dependent on the operational parameters, like RF output power, amount of traffic
- This product has internal temperature sensors that will issue alarms for too high or too low temperature. The operating conditions shall be ensured so that the normal operation does not cause temperature alarms. Any temperature alarms shall be immediately rectified. See reference document Software 6 Management Guide [1] for detailed specification of the temperature sensors alarms.

### 3.3.4 Installations at Very High Temperatures

For installations, where the product is operated close to its maximum specified ambient temperature ( $+55^{\circ}\text{C}$   $< T_{\text{Ambient}} < +70^{\circ}\text{C}$ ), it must be ensured that the natural convection is not blocked by objects close to the product.

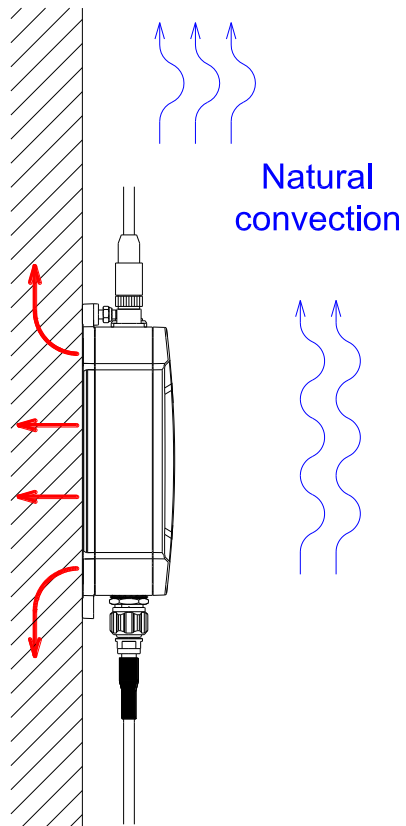


**Figure 8 Installation with blocked airflow shall be avoided**



**Figure 9 Installation with free airflow - good installation**


When operating the device at ambient temperatures above app. +60C it is recommended to mount the device to a metallic base plate to improve the heat dissipation. The base plate increases the surface to spread the heat.



**Figure 10 Improved heat transfer based on fixing plate**

### 3.4 Connecting the Protective Earth

There is a single grounding connection point in RT-220. An M5 grounding screw at the housing is used for grounding (see Figure 11).

	<p><b>Danger!</b></p> <p>Do not use equipment without protective earth connection.</p>
---	--

**NOTICE:** The grounding is organized by connecting the grounding to the ground contact in the casing. For the grounding at the ground contact (M5 stud), a short wire with a cross section of at least 6.0 mm<sup>2</sup> shall be used.

The grounding wire is set below the rip-lock washer. The nut is fixed for good reliable grounding contact. The tightening torque of the nut shall be 2.0 Nm.

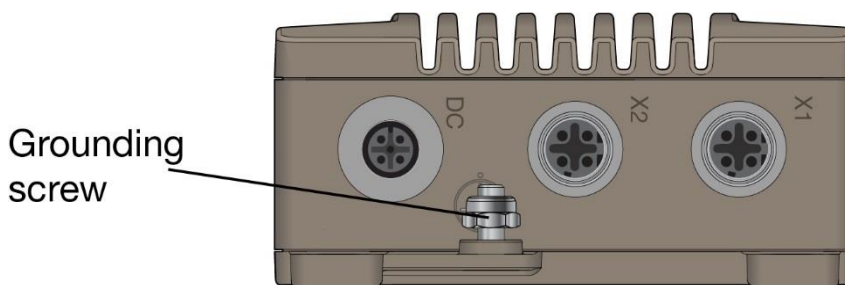


Figure 11 Grounding contact

### 3.5 Connecting the RF Antenna Interfaces

#### 3.5.1 RF Antenna Interface Operation Modes

RT-220 has two antenna interfaces. The antenna interfaces are operating independently of each other.

<i>Antenna Function</i>	<i>Operation</i>	<i>Notes</i>
<b>A1</b>	Antenna 1 is used for both transmitting and receiving	The antenna A1 shall be used.
<b>A2</b>	Antenna 2 is used for both transmitting and receiving	The antenna A2 can be enabled or disabled.

Table 12 RF Antenna interface operation

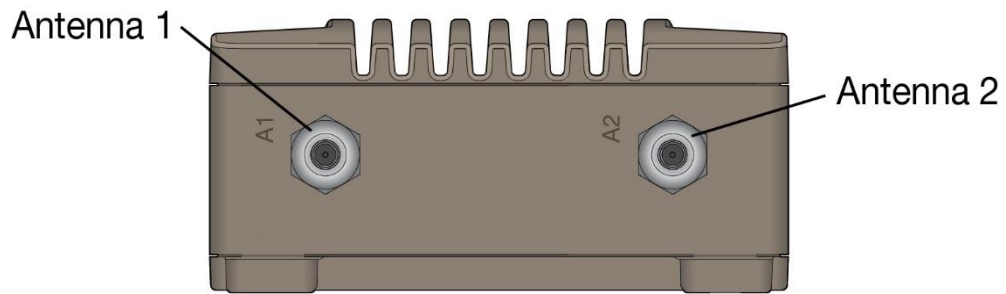
**NOTICE:** If antenna A2 will be NOT used in the customer application, the antenna connector MUST be terminated with a 50 ohm termination.

**NOTICE:** The antenna interfaces are protected against lightning with special protection devices. To ensure correct operation of these devices it is important, that the earth grounding contact is connected to protective earth as described in chapter 3.4.

### 3.5.2 RF Antenna Connectors

The antenna connectors are identified with the text markings A1 (Antenna 1) and A2 (Antenna 2) in the mechanics.

The antennas might be fixed in antenna connectors directly or using antenna cables fixed to the antenna connectors.



**Figure 12 Antenna interfaces**

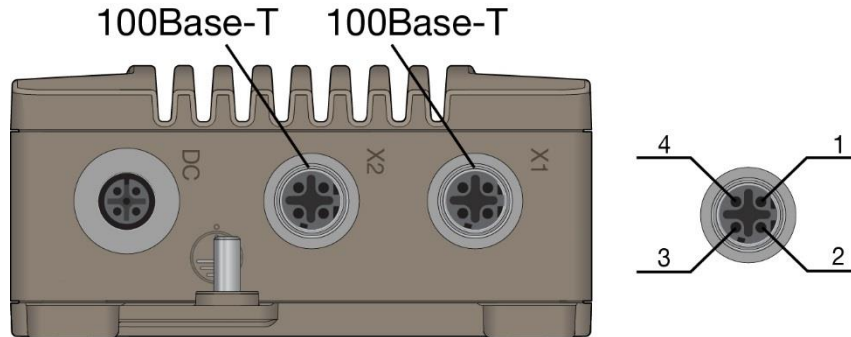
**NOTICE:** If one of the antennas is NOT used, the unused antenna connectors MUST be terminated with 50 ohm termination.

<b>Pin</b>	<b>Signal Name, Function</b>	<b>Notes</b>
<b>1</b>	Center pin: RF signal	Connector Type: QMA – Female
<b>2</b>	Connector body: RF ground	

**Table 13 Pinning: RF antenna connector**

### 3.6 Connecting Ethernet Interface

RT-220 has two Ethernet interfaces. M12 industrial standard connector with keying is used. The Ethernet connectors are identified with the text markings X1 (Ethernet 1<sup>1</sup>) and X2 (Ethernet 2) in the mechanics.



**Figure 13 Ethernet interfaces**

The connectors should be assembled with correct torque (approx. 1.0 Nm, check connector manufacturer data)

**NOTICE:** Ethernet signals have a transformer in the signal lines. There is no additional line protection for Lightning etc included at product hardware module.

#### 3.6.1 Ethernet Port Features

The Ethernet port supports the following network standards:

<i>Network Standard</i>	<i>Description</i>
<b>10BASE-T</b>	Ethernet over two pairs of twisted wires
<b>100BASE-TX</b>	Fast Ethernet over two pairs of twisted wires

**Table 14 Ethernet port features**

The Ethernet ports support auto-negotiated 10 Mbit/s / 100 Mbit/s operation. Automatic MDI/MDIX crossover is supported for 100BASE-TX and 10BASE-T operation. For final installation the use of auto-negotiation is however not recommended.

---

<sup>1</sup> PoE for RT-220-LV only



### 3.6.2 Ethernet Connector

<b>Connector Pin</b>	<b>Signal name, Function</b>	<b>Notes</b>
<b>1</b>	Transmission Data +	Connector Type: Industrial ETHERNET M12-Socket "D"-coded
<b>2</b>	Transmission Data -	
<b>3</b>	Receiver Data +	
<b>4</b>	Receiver Data -	
<b>Housing</b>	Ground	For possible cable protection/screening

**Table 15 Ethernet connector**

**NOTICE:** The pinning is compliant to IONA, Industrial Ethernet Planning and Installation Guide, Release 4.0.

### 3.6.3 PoE Connection (X1 and RT-220-LV only)

<b>Connector Pin</b>	<b>1000 mode A</b>	<b>Notes</b>
<b>1, 2</b>	DC+	Connector Type: Industrial ETHERNET M12-Socket "D"-coded
<b>3, 4</b>	DC-	
<b>Housing</b>	Ground	For possible cable protection/screening

**Table 16 PoE connection**

### 3.6.4 PoE Power Feed Specifications

<b>Parameter</b>	<b>Value</b>	<b>Notes</b>
<b>Nominal Voltage</b>	48 VDC	
<b>Voltage Range</b>	37 VDC ... 57 VDC	
<b>Power classification</b>	Class 3	
<b>PSE supply mode</b>	A	Device supports PSE supply mode A only

**Table 17 PoE power feed specifications**

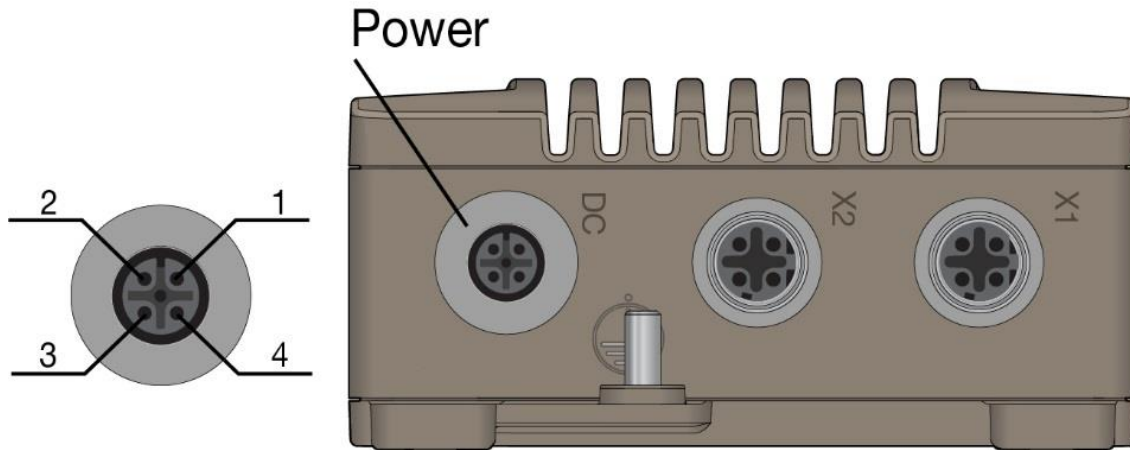
### 3.7 Connecting the Power Feed

The power feed is connected to the POWER connector. The power supply interface is a galvanically isolated interface; it is protected against surge and ESD. The power connector is keyed ensuring correct connector position.

**NOTICE:** The Power Feed Cable is not part of delivery.

#### 3.7.1 Power Feed Connector

**Connector type:** M12 A-coded 4-pin male connector according to IEC 61076-2-101.



**Figure 14 RT-220, power connector**

**NOTICE:** Power connector pinning: clockwise 1, 4, 3, 2 starting from the coding mark.

Pin	Signal Name, Function	Notes
1	VCC+	The positive supply voltage is applied
2	Not used	
3	VCC-	The negative supply voltage is applied
4	Not used	

**Table 18 Pinning: PWR connector**

### 3.7.2 Power Feed Specifications

<i>Parameter</i>	<i>RT-220-LV</i>	<i>RT-220-HV</i>	<i>Notes</i>
<b>Nominal Voltage</b>	24VDC	72-110VDC	
<b>Voltage Range</b>	16 – 30VDC	50 – 138VDC	
<b>Nominal current</b>	0.6A	0.2A	
<b>Power consumption</b>	App. 4W App. 8W	App. 4W App. 8W	with no user data with full user data load
<b>Selecting external power connector and power cable diameter - Allowed wire cross section</b>	Min. 0.5mm <sup>2</sup>	Min. 0.5mm <sup>2</sup>	Cable Plug: e.g. Phoenix Contact, SACC-M12FS-4CON-PG7-M

**Table 19 Power feed specifications**

### 3.7.3 Power supply ripple

According to EN50155 the voltage ripple of the power supply may be 10% of the nominal voltage. Otherwise too high touch current may result.

## 4 Configuration and Use

The operation parameters in configuration files define the functionality. The complete configuration process is described in reference document Software 6 Management Guide [1].

### 4.1 LED Indicators During Power Up Sequence

LED behavior during power-up sequence is described in reference document Software 6 Management Guide [1] in the chapter Status Indication.

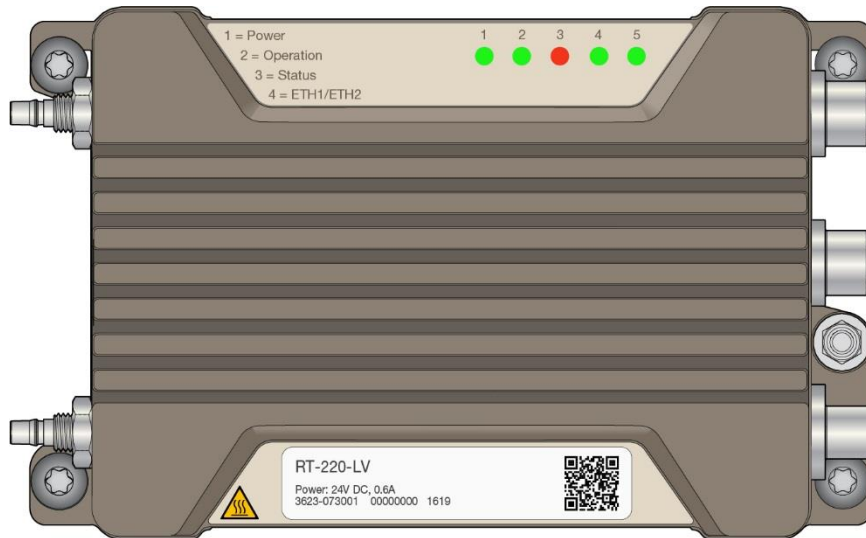


Figure 15 Power, operation, status and Ethernet LEDs

### 4.2 Factory Reset Interface, Process for Factory Reset

A factory reset is not typically needed for installation. It is required if the device configuration is lost.

The factory reset functionality is included in both Ethernet port interfaces. The factory reset process is performed using specific factory reset adapter.

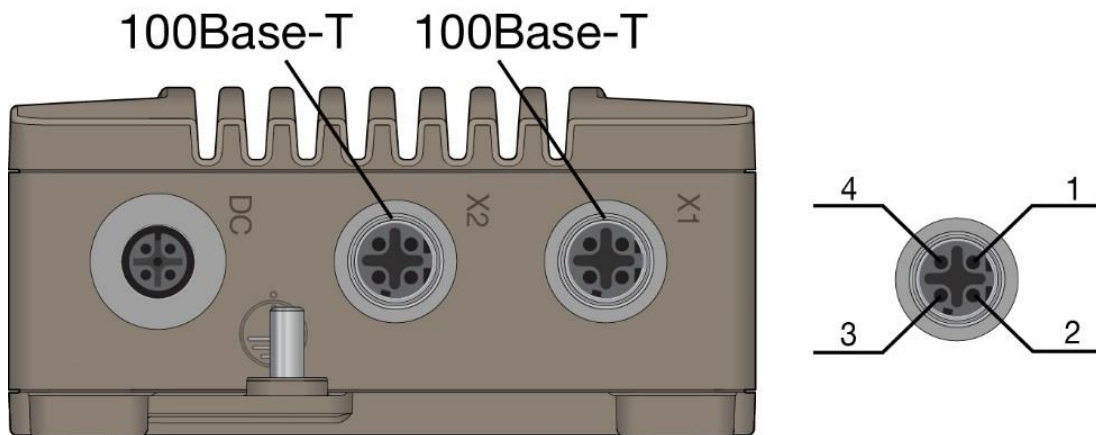


Figure 16 Ethernet Port for Factory Reset

**NOTICE:** The Ethernet Interface connector fulfills the IP66 protection when the cable plug or the dust cap is connected. If the Ethernet function is not used in application, the protective dust cap must be closed.

### 4.2.1 Factory Reset Adapter Specification

The factory reset adapter is a special plug for the Ethernet interface that activates the factory reset signal.

There is a specific factory reset adapter available:

FACTORY RESET PLUG D-CODED

Part No.: 3623-0795



Figure 17 Factory reset plug D-coded

### 4.2.2 Factory Reset Procedure



The Factory Reset is performed with a factory reset adapter that is connected to one of the Ethernet ports during the start-up.

Step	Description
1.	Plug the factory reset adapter to one of the Ethernet interfaces.
2.	Power the device
3.	Wait until factory reset adapter is detected. This is indicated by an ORANGE operation LED in combination with a RED status LED
4.	Remove factory reset adapter within 15 seconds
5.	A successful initiation of a factory Reset is indicated by an ORANGE BLINKING operation LED in combination with a RED BLINKING failure LED

Table 20 Factory reset procedure

After successful factory reset, the dust cap must be closed to ensure the IP requirements.

## 5 Maintenance

	<b>Danger!</b> Never open the device. There are no serviceable parts inside!
	<b>Warning!</b> Maintenance shall be done by trained staff only.

### 5.1 Cleaning– Resistance to Chemicals

In case the product is cleaned with cleaning chemicals, the resistance to chemicals of the plastic parts needs to be respected. The following plastic materials are used in the RT-220:

#### **Ethernet Connector Dust Cap**

Polyamide 66 (PA66)

Polyurethane (PUR)

#### **Pressure Equalizer Vent**

Polyamide 6 (PA6)

Polytetrafluoroethylene (PTFE)

#### **Stickers**

Autotex XE

## 5.2 Troubleshooting Based on Functional Behavior

Please read the troubleshooting instructions in reference document Software 6 Management Guide [1].

## 5.3 Repair Work

This product is exchanged as a whole unit. On product level no repair work is done in the field. Broken units need to be returned to the supplier for repair.

### 5.3.1 Exchange of the Product

<b><i>Order of Installation Step</i></b>	<b><i>Description</i></b>
<b>1. Remove Cables</b>	Remove cables in the following order: <ol style="list-style-type: none"> <li>1. Power cable (or PoE cable)</li> <li>2. Antenna cables</li> <li>3. Ethernet cables</li> <li>4. Protective earth cable</li> </ol>
<b>2. Open Screw</b>	The four M6 screws in each corner of the RT-220 must be opened and removed completely
<b>3. Exchange</b>	Lift the product out of its position. Place a replacement unit to its position
<b>4. Fix Screws</b>	The four M6 screws in each corner must be fixed again.
<b>5. Connect Cables</b>	Connect cables in the following order: <ol style="list-style-type: none"> <li>1. Protective earth cable</li> <li>2. Antenna cables</li> <li>3. Ethernet cables</li> <li>4. Power cable</li> </ol>
<b>6. Configure</b>	Download configuration to the product

Table 21 Exchange flow